

SAFETY PRECAUTIONS



CAUTION

**RISK OF ELECTRIC SHOCK
DO NOT OPEN**



CAUTION: TO REDUCE THE RISK OF ELECTRIC SHOCK, DO NOT REMOVE COVER (OR BACK). NO USER-SERVICEABLE PARTS INSIDE. REFER SERVICING TO QUALIFIED SERVICE PERSONNEL.



DANGEROUS VOLTAGE:

The lightning flash with arrowhead symbol within an equilateral triangle is intended to alert the user to the presence of uninsulated dangerous voltage within the product's enclosure that may be of sufficient magnitude to constitute a risk of electric shock to persons.



ATTENTION:

The exclamation point within an equilateral triangle is intended to alert the user to the presence of important operating and maintenance (servicing) instructions in the literature accompanying the appliance.

FCC WARNING:

This equipment may generate or use radio frequency energy. Changes or modifications to this equipment may cause harmful interference unless the modifications are expressly approved in the instruction manual. The user could lose the authority to operate this equipment if an unauthorized change or modification is made.

ATTENTION:

POUR ÉVITER LES CHOC ÉLECTRIQUES, INTRODUIRE LA LAME LA PLUS LARGE DE LA FICHE DANS LA BORNE CORRESPONDANTE DE LA PRISES ET POUSSER JUSQU'AU FOND.

SAFETY PRECAUTIONS

INFORMATION:

This equipment complies with Class B digital device regulations. This equipment generates, uses and can radiate radio frequency energy and, if not installed and used in accordance with the instructions, may cause harmful interference to radio communications. However, there is no guarantee that interference will not occur in a particular installation. If this equipment does cause harmful interference to radio or television reception, which can be determined by turning the equipment off and on, the user is encouraged to try to correct the interference by one or more of the following measures:

- Reorient or relocate the receiving antenna.
- Increase the separation between the equipment and receiver.
- Connect the equipment into an outlet on a circuit different from that to which the receiver is connected.
- Consult the dealer or an experienced radio/TV technician for help.

WARNING: TO PREVENT FIRE OR SHOCK HAZARD, DO NOT EXPOSE THIS UNIT TO RAIN OR MOISTURE.

SURGE PROTECTORS:

It is recommended to use a surge protector for AC connection. Lightning and power surges ARE NOT covered under warranty for this product.

This Class B digital apparatus complies with Canadian ICES-003.

Cet appareil numérique de la classe B est conforme à la norme NMB-003 du Canada.

Dear Customer:

Selecting fine audio and video equipment such as the unit you've just purchased is only the start of your musical enjoyment. Now it's time to consider how you can maximize the fun and excitement your equipment offers. This manufacturer and the Electronic Industries Association's Consumer Electronics Group want you to get the most out of your equipment by playing it at a safe level. One that lets the sound come through loud and clear without annoying blaring or distortion-and, most importantly, without affecting your sensitive hearing. Sound can be deceiving. Over time your hearing "comfort level" adapts to higher volumes of sound. So what sounds "normal" can actually be loud and harmful to your hearing. Guard against this by setting your equipment at a safe level BEFORE your hearing adapts.

To establish a safe level:

- Start your volume control at a low setting.
- Slowly increase the sound until you can hear it comfortably and clearly, and without distortion.

Once you have established a comfortable sound level:

- Set the dial and leave it there.

Taking a minute to do this now will help to prevent hearing damage or loss in the future. After all, we want you listening for a lifetime.

We Want You Listening For A Lifetime

Used wisely, your new sound equipment will provide a lifetime of fun and enjoyment. Since hearing damage from loud noise is often undetectable until it is too late, this manufacturer and the Electronic Industries Association's Consumer Electronics Group recommend you avoid prolonged exposure to excessive noise. This list of sound levels is included for your protection.

Decibel

<u>Level</u>	<u>Example</u>
30	Quiet library, soft whispers
40	Living room, refrigerator, bedroom away from traffic
50	Light traffic, normal conversation, quiet office
60	Air conditioner at 20 feet, sewing machine
70	Vacuum cleaner, hair dryer, noisy restaurant
80	Average city traffic, garbage disposals, alarm clock at two feet

THE FOLLOWING NOISES CAN BE DANGEROUS UNDER CONSTANT EXPOSURE:

90	Subway, motorcycle, truck traffic, lawn mower
100	Garbage truck, chain saw, pneumatic drill
120	Rock band concert in front of speakers, thunderclap
140	Gunshot blast, jet engine
180	Rocket launching pad

Information courtesy of the Deafness Research Foundation.



LOCATION OF CONTROLS

MAIN UNIT

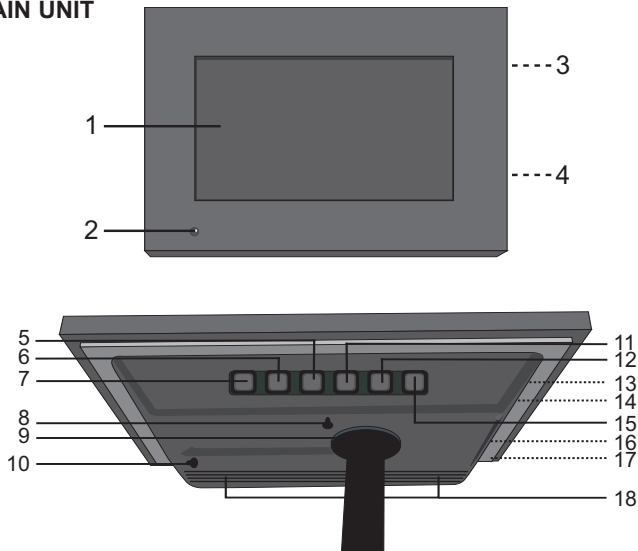

1. Screen
2. Remote Sensor
3. SD/MMC/MS/xD Card Slot (Side of Unit)
4. CF Card Slot (Side of Unit)
5. Navigation ▼ Button
6. Navigation ▲ Button
7. ENTER/PLAY Button
8. Wall Mount Hole
9. Stand
10. Wall Mount Hole
11. Navigation ►/
VOLUME + Button
12. Navigation ◀/
VOLUME - Button
13. Power Button (Side of Unit)
14. USB Jack (Side of Unit)
(USB CABLE PART NO. 337-01000-E050*)
15. EXIT/CANCEL Button
16. Headphones Jack (Side of Unit)
17. DC 12V IN Jack (Side of Unit)
(AC ADAPTER PART NO. 295-04981-E000*)
18. Speakers

***Consumer Replaceable Part
(See page 21 to order.)**

LOCATION OF CONTROLS (CONTINUED)

REMOTE

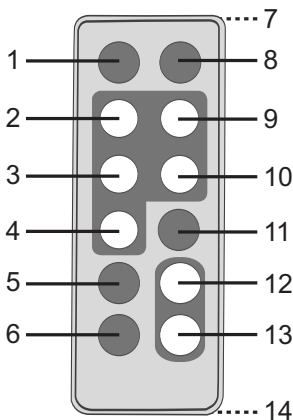

1. MUTE Button
2. Navigation ◀/VOLUME - Button
3. Navigation ▲ Button
4. Navigation ▼ Button
5. MENU Button
6. EXIT Button
7. Remote Transmitter (Top of Unit)
8. TIME Button
9. Navigation ▶/ VOLUME + Button
10. ENTER/PLAY Button
11. ROTATE Button
12. ZOOM IN Button
13. ZOOM OUT Button
14. Battery Compartment (Rear of Unit)

REMOTE PART NO. 239-04421-E001*

***Consumer Replaceable Part (See page 21 to order.)**

POWER SOURCE

AC CONNECTION

Insert the small end of the AC adapter into the DC 12V IN jack (located under the left cover on the side of this unit). Connect the other end to a wall outlet having 120V AC, 60 Hz.

AC Adapter, DC 12V 

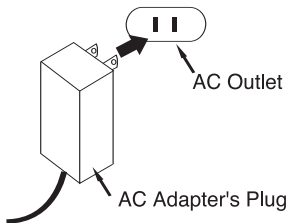

NOTES:

- Remove both the DC plug and the AC-IN plug to disconnect the AC adapter when not in use.
- Only use the supplied AC adapter which has the following specs: DC 12V 

REMOTE BATTERY INSTALLATION

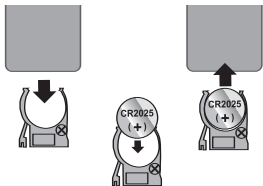

1. Remove the Battery Compartment by pressing in on the tab and then sliding the compartment out.
2. Install a CR2025 battery, paying attention to the polarity diagram in the Battery Compartment (positive side up).
3. Replace the Battery Compartment.

BATTERY PRECAUTIONS

Follow these precautions when using batteries in this device:

1. Warning—Danger of explosion if batteries are incorrectly replaced. Replace only with the same or equivalent type.
2. Use only the size and type of batteries specified.
3. Be sure to follow the correct polarity when installing the batteries as indicated next to the battery compartments. A reversed battery may cause damage to the device.
4. If the device is not to be used for a long period of time, remove the batteries to prevent damage or injury from possible battery leakage.
5. Do not try to recharge a battery not intended to be recharged; it can overheat and rupture. (Follow battery manufacturer's directions.)

OPTIONAL FEATURES

HEADPHONES JACK (SIDE OF UNIT)

For private listening, plug headphones into this jack. The speakers will be disconnected when a plug is inserted into this jack.

WALL MOUNT HOLES (2) (REAR OF UNIT)

If desired, the digital frame can be mounted onto a wall. Simply hang using the Wall Mount holes, as you would hang an ordinary photo frame or painting.

STAND (REAR OF UNIT)

To use the stand, lift the stand up and then rotate counterclockwise until it is in position. When viewing photos vertically, it is recommended that you gently pull the stand back a little further to ensure that the frame is stable.

GETTING STARTED

USING A MEMORY CARD

You can access media files from an external memory card as described below. This unit accepts memory cards up to these sizes: SD up to 2GB, MMC up to 1GB, MS up to 1GB, xD up to 1GB and CF up to 2GB.

1

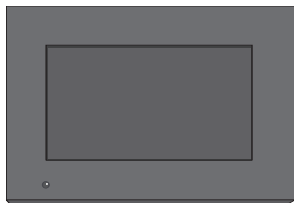

Back of
the card

Back of
the card

TO INSERT A MEMORY

CARD: This unit can support SD (Secure Digital), MMC (MultiMedia Card), MS (Memory Stick), xD or CF (CompactFlash) memory cards. Simply insert the SD, MMC, MS or xD card into the top Card Slot located at the right side of the unit, with the card facing towards the rear of the unit (as shown).

Insert the CF card in the same manner, but using the bottom Card Slot.

2

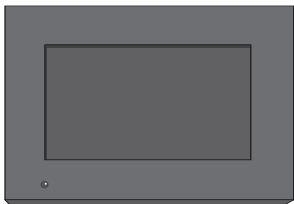

Back of
the card

Back of
the card

TO REMOVE A MEMORY

CARD: Press the Power button to the Off (out) position to turn it off. With the power off, remove the memory card by pulling it out gently. You may need to wiggle it back and forth to dislodge it from the frame.

Please place under 300 photo files on the memory card, otherwise some photos may not appear in the frame.

GETTING STARTED (CONTINUED)

COPYING MEDIA FILES FROM YOUR COMPUTER

You can also copy media files directly from your computer to this digital frame using a USB cable.

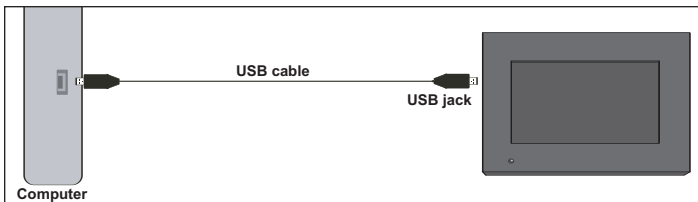

1. Connect this unit to an AC power source, as shown on page 6, and turn this unit on by pressing the Power button to the On (in) position. This unit will either show the Main menu or automatically start showing a photo Slideshow (if the Auto Play option in the Setup menu is set to ON). If the unit is in Slideshow mode, press the EXIT button twice to exit and access the Main menu.
2. Connect the USB cable to the USB jack located under the left cover of this unit and connect the other end to your computer (as shown).
3. On your computer, double-click My Computer. This unit will appear as a removable drive named "Memorex".
4. Navigate to the media files that you want to copy. Then, drag and drop them to the "Memorex" drive. (Refer to the owners manual accompanying your computer for more information on copying files.)

NOTES:

- If a memory card is inserted (as shown on the previous page) and is selected as the Select Card option in the Setup menu (as shown on page 19), the memory card, not this unit, will appear as a removable drive in Step 3.
- You can also copy files from the digital frame or external memory card to your computer, if desired.

OPERATION

SETTING THE TIME AND DATE

1

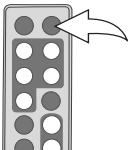

Press the Power button to the On (in) position to turn the unit on.

This unit will either show the Main menu or automatically start showing a photo Slideshow (if the Auto Play option in the Setup menu is set to ON).

Press the TIME button to access the clock/calendar page.

2

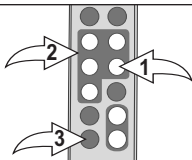

Press the ENTER/PLAY button ❶ to start setting the time and date.

Use the Navigation ▲, ▼ buttons ❷ to set the current hour (make sure to set the correct AM/PM setting if you selected the 12 Hour mode in the Time Mode Setup option).

Press the Navigation ► button ❸ to select the minutes. Use the Navigation ▲, ▼ buttons ❷ to set the current minutes.

Repeat to set the month, day and year.

To save your setting press ENTER/PLAY button ❶, then press EXIT button ❸ return to main menu.

ACCESSING THE CLOCK/CALENDAR PAGE

1

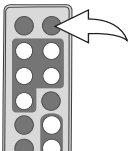

The clock/calendar page will automatically appear after one minute of inactivity. You can also press the TIME button at any time to access the clock/calendar page.

2

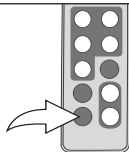

To exit and return to the Main menu, press the EXIT button.

OPERATION (Continued)

BASIC PHOTO PLAYBACK (Supported format: JPEG)

1

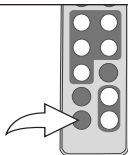

Press the Power button to the On (in) position to turn the unit on.

This unit will either show the Main menu or automatically start showing a photo Slideshow (if the Auto Play option in the Setup menu is set to ON).

If the unit is in Slideshow mode, press the EXIT button twice to exit and access the Main menu

2

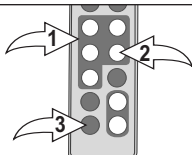

Select Photo using the Navigation ◀, ▶, ▲, ▼ buttons ❶; then press the ENTER/PLAY button ❷ to enter the Photo Thumbnail view.

Select the desired photo, or page of photos, to view using the Navigation ◀, ▶, ▲, ▼ buttons ❶; then press the ENTER/PLAY button ❷ again to playback the selected photo. Press the ENTER/PLAY button ❷ again to begin a Slideshow of all photos from the selected media source.

To stop playback and return to the Photo Thumbnail view, press the EXIT button ❸. Press again to exit to the Main menu.

OPERATION (Continued)

ZOOM

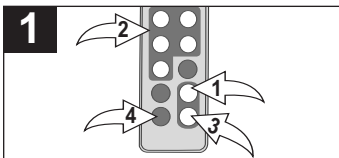

While viewing a photo (see the previous page), press the ZOOM IN button ❶; the unit will zoom x2. Repeatedly press to zoom up to x13.

Use the Navigation ◀, ▶, ▲, ▼ buttons ❷ to move the photo on the screen.

Press the ZOOM OUT button ❸ to zoom back out of the photo.

To exit Zoom mode and return to normal photo playback, press the EXIT button ❹.

ROTATE

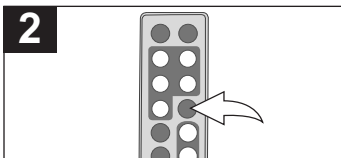

While viewing a photo (see the previous page), press the ROTATE button to rotate the photo 90 degrees clockwise. Repeat to continue to rotate as desired.

SKIP

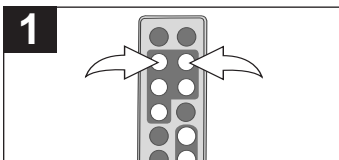

While viewing a photo (see the previous page), press the Navigation ◀ and/or ▶ button to skip to the previous or next picture.

OPERATION (Continued)

PHOTO “FAVORITES” PLAYBACK

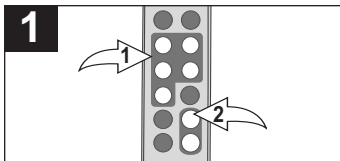

While in Photo Thumbnail view (see page 11), select a photo to add to your Favorites using the Navigation ◀, ▶, ▲, ▼ buttons ❶. Then press the ZOOM IN button ❷ to confirm; a red frame will appear around the selected photo.

NOTE: To deselect the photo, simply press the ZOOM IN button again.

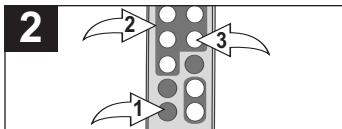

Press the EXIT button ❶ to exit to the Main menu. Select Favorites using the Navigation ◀, ▶, ▲, ▼ buttons ❷; then press the ENTER/PLAY button ❸ to enter the Favorites menu.

To change the favorite's view (Single photo or Double photos) on the screen, select Play Mode using the Navigation ▲, ▼ buttons ❷. Then, press the Navigation ◀, ▶, ▲, ▼ buttons ❸ to select between Single or Double; then press the OK button ❹ again to confirm.

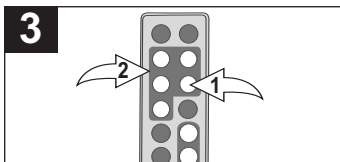

In the Favorites menu, you have the option of selecting to view your Favorites in Landscape or Portrait mode. Press the ENTER/PLAY button ❶ to select Direction. Then, press the Navigation ◀, ▶, ▲, ▼ buttons ❷ to select between Landscape and Portrait; then press the ENTER/PLAY button ❸ again to confirm.

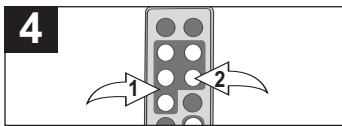

Once you have chosen the viewing mode (if desired), select Play using the Navigation ▲, ▼ buttons ❶; then press the ENTER/PLAY button ❷ to confirm and start playback of your Favorites. **OR** To exit the Favorites menu and return to the Main menu, select Exit using the Navigation ▲, ▼ buttons ❶; then press the ENTER/PLAY button ❷ to confirm.

NOTE: You can also press the EXIT button to exit the Favorites menu.

TO CLEAR THE FAVORITES PLAY LIST: In Photo Thumbnail view, press the ROTATE button; a pop-up window will appear. Select “No” (to NOT clear the Favorites) or “Yes” (to clear the Favorites) using the Navigation ◀, ▶ buttons; then press the ENTER/PLAY button to confirm.

OPERATION (Continued)

BASIC MUSIC PLAYBACK (Supported format: MP3)

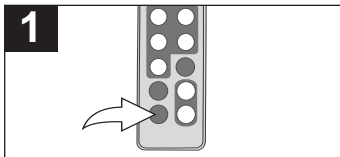

1

Press the Power button to the On (in) position to turn the unit on. This unit will either show the Main menu or automatically start showing a photo Slideshow (if the Auto Play option in the Setup menu is set to ON). If the unit is in Slideshow mode, press the EXIT button twice to exit and access the Main menu.

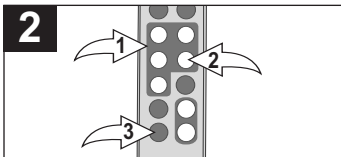

2

Select Music using the Navigation ◀, ▶, ▲, ▼ buttons ❶; then press the ENTER/PLAY button ❷ to enter the Music menu. Select the desired MP3 to listen to using the Navigation ▲, ▼ buttons ❶; then press the ENTER/PLAY button ❷ again to confirm. Playback will begin with the MP3 that you selected. To stop playback and return to the Main menu, press the EXIT button ❸.

ADJUSTING THE VOLUME

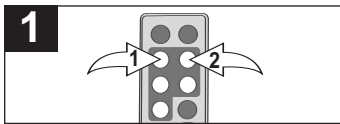

1

To adjust the main volume:
Press the Navigation ◀/VOLUME - ❶ and/or Navigation ▶/VOLUME + ❷ button to increase and/or decrease the volume.

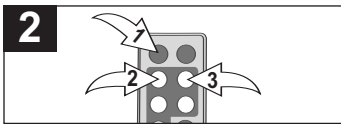

2

To mute the main volume:
Press the MUTE button ❶. Press this button again, or either of the Navigation ◀/VOLUME - ❷ and/or Navigation ▶/VOLUME + ❸ buttons to unmute.

NOTES:

- See page 19 to select a Play Mode (i.e. Repeat All, etc.).
- You can pause playback at anytime by pressing the ENTER/PLAY button; the Pause icon will appear on screen and the file will remain paused until the button is pressed again.
- You can use the Navigation ▲, ▼ buttons to skip to the previous or next MP3 file.

OPERATION (Continued)

BASIC VIDEO PLAYBACK (Supported format: MOV)

Video: Compress type: MPEG-4 Video Frame Rate: 30fps
Dimensions: 352 x 288 CIF

Audio: μ -Law 2:1 or A-Law 2:1

1

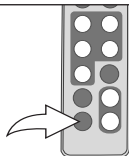

Press the Power button to the On (in) position to turn the unit on.

This unit will either show the Main menu or automatically start showing a photo Slideshow (if the Auto Play option in the Setup menu is set to ON).

If the unit is in Slideshow mode, press the EXIT button twice to exit and access the Main menu.

2

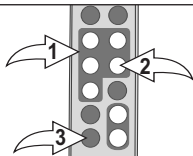

Select Movie using the Navigation \blacktriangleleft , \blacktriangleright , \blacktriangleup , \blacktriangledown buttons ①; then press the ENTER/PLAY button ② to enter the Movie menu. Select the desired video to watch using the Navigation \blacktriangleleft , \blacktriangleright , \blacktriangleup , \blacktriangledown buttons ①; then press the ENTER/PLAY button ② again to confirm. Playback will begin with the video file that you selected. Press ENTER/PLAY button ② to pause the video, press again to resume playback. To stop playback and return to the Movie menu, press the EXIT button ③. Press again to exit to the Main menu.

ADJUSTING THE VOLUME

1

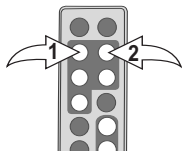

To adjust the main volume:

Press the Navigation \blacktriangleleft /VOLUME - ① and/or Navigation \blacktriangleright /VOLUME + ② button to increase and/or decrease the volume.

2

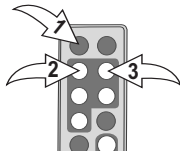

To mute the main volume:

Press the MUTE button ①. Press this button again, or either of the Navigation \blacktriangleleft /VOLUME - ② and/or Navigation \blacktriangleright /VOLUME + ③ buttons to unmute.

OPERATION (Continued)

DELETING A FILE

1

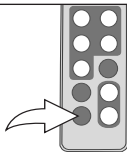

Press the Power button to the On (in) position to turn the unit on.

This unit will either show the Main menu or automatically start showing a photo Slideshow (if the Auto Play option in the Setup menu is set to ON).

If the unit is in Slideshow mode, press the EXIT button twice to exit and access the Main menu

2

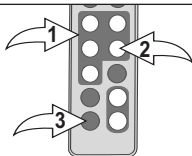

Select Folder using the Navigation ◀, ▶, ▲, ▼ buttons ①; then press the ENTER/PLAY button ② to enter the Folder menu.

Select the desired file to delete using the Navigation ▲, ▼ buttons ①. Then press the Navigation ◀ button ①; a pop-up menu will appear.

Select “No” (to NOT delete the file) or “Yes” (to delete the file) using the Navigation ◀, ▶ buttons ①; then press the ENTER/PLAY button ② again to confirm.

To return to the Main menu, press the EXIT button ③.

OPERATION (Continued)

COPYING A FILE

1

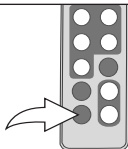

Press the Power button to the On (in) position to turn the unit on.

This unit will either show the Main menu or automatically start showing a photo Slideshow (if the Auto Play option in the Setup menu is set to ON).

If the unit is in Slideshow mode, press the EXIT button twice to exit and access the Main menu.

2

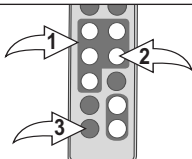

Select Folder using the Navigation ◀, ▶, ▲, ▼ buttons ❶; then press the ENTER/PLAY button ❷ to enter the Folder menu.

Select the desired file to copy using the Navigation ▲, ▼ buttons ❶. Then press the Navigation ▶ button ❶; a pop-up menu will appear.

Select "No" (to NOT copy the file) or "Yes" (to copy the file) using the Navigation ◀, ▶ buttons ❶; then press the ENTER/PLAY button ❷ again to confirm.

To return to the Main menu, press the EXIT button ❸.

NOTES:

- While copying a file, if more than one target media (media to copy to) is available, select the target media when prompted by the pop-up window to do so.
- If the target media is full, "Disk is Full" will appear.
- While copying a file, if there is already a file with the same name on the target media, a "Would you like to replace the existing file?" pop-up window will appear. Select "No" (to NOT replace the file by cancelling the copy request) or "Yes" (to replace the file) using the Navigation ◀, ▶ buttons; then press the ENTER/PLAY button again to confirm.
- You can only delete or copy a file, not a folder. If you have selected a folder, pressing the Navigation ▶ button will enter the directory and pressing the Navigation ◀ button will exit the directory.
- Copying or deleting a file will also clear your Favorites play list.

OPERATION (Continued)

SETUP MENU

The Setup menu lets you customize this digital frame by allowing you to select the source for your media files, set the effects between your photos, adjust the speed of the Slideshow and more!

Use the following instructions to navigate and change the options which are described on the following page.

1. Press the Power button to the On (in) position to turn the unit on.

This unit will either show the Main menu or automatically start showing a photo Slideshow (if the Auto Play option in the Setup menu is set to ON).

If the unit is in Slideshow mode, press the EXIT button ❶ twice to exit and access the Main menu.

2. Select Setup using the Navigation ◀, ▶, ▲, ▼ buttons ❷; then press the ENTER/PLAY button ❸ to enter the Setup menu. (**NOTE:** You can also access the Setup menu at any time by pressing the MENU button.)
3. Use the Navigation ▲, ▼ buttons ❷ to select one of the Setup options (i.e. "Select Card") on the two available pages of options, then press the ENTER/PLAY button ❸ to select it; the option will be highlighted in blue.
4. Use the Navigation ▲, ▼ buttons ❷ to change the desired option setting (i.e. choose between SD/MMC, Internal Flash, etc.), then press the ENTER/PLAY button ❸ to make the change.
5. Exit by pressing the EXIT button ❶. (**NOTE:** You can also exit by selecting the Exit Setup option.)

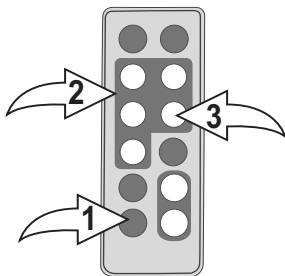

CONTINUED ON THE NEXT PAGE

OPERATION (Continued)

SETUP OPTIONS

Select Card: Use this Setup option to select the source for your media files. Choose from Internal Flash, as well as any external media inserted (i.e. SD/MMC).

Photo Mode: Use this Setup option to select the mode in which the photos will be displayed. Choose from Full (which will stretch the picture to fill the screen) or Normal (which will display the photo with its original proportions).

Slide Effect: Use this Setup option to select the transition effect between your slides. Choose from Split Out, Split In, Cut Out, Cut In, Wrap Left, Wrap Right, Wrap Up, Wrap Down or Random (will randomly select among the other modes to transition between the photos).

Slide Speed: Use this Setup option to select the speed for your Slideshow. Choose from Slow, Medium or Fast.

Auto Play: Use this Setup option to choose whether your frame will automatically start showing a photo Slideshow after being turned on. Choose to set Auto Play to ON or OFF.

Music Mode: Use this Setup option to select a Play mode when listening to MP3s on this unit. Choose from Repeat All (will repeat all of the files from the selected media source continuously until you exit the Music menu), Repeat One (will repeat the selected file continuously until you exit the Music menu) or Repeat Off (for Normal Music playback).

Background Music: Use this Setup option to choose whether your frame will play background music while viewing a Slideshow. Choose to set Background Music to ON or OFF. The volume of the Background music can be adjusted in the same way as normal music playback (see page 14).

Brightness: Use this Setup option to adjust the brightness of the screen. Choose from 00% to 100%.

Time Mode: Use this Setup option to set the internal clock to 12 or 24 hour mode. Choose from 12 Hour or 24 Hour.

Language: Use this Setup option to select the desired language for the menus. Choose from English, Spanish or French.

TROUBLESHOOTING GUIDE

If you experience a problem with this unit, check the chart below before calling for service.

SYMPTOM	CAUSE	SOLUTION
Main unit, no power.	AC adapter is not connected.	Connect AC adapter as shown on page 6.
Remote, no power.	Battery not inserted or inserted incorrectly.	Insert battery correctly as shown on page 6.
No photos in frame.	No photos are present in Internal Flash or external media source.	Copy files onto the frame or insert external media source, see pages 8 & 9.
Computer does not recognize frame as a Removable Disk.	USB cable not connected securely.	Secure USB cable connection.
	Frame is not turned on.	Turn on frame using the Power switch on the rear of the frame.

SPECIFICATIONS

GENERAL:

Power Source	AC Adapter, DC 12V 
Weight.....	2 Lbs
Dimensions	8.5" (H) x 11.9" (W) x 1.75" (D)
Weight and dimensions are approximate.	
Resolution	800 x 480
Internal Memory	128MB
Speaker	2 x 0.6 W

Specifications are subject to change without notice.

FOR ADDITIONAL SET-UP OR OPERATING ASSISTANCE, PLEASE VISIT OUR WEBSITE AT:

WWW.MEMOREXELECTRONICS.COM

OR CONTACT CUSTOMER SERVICE AT 1-800-919-3647.

PLEASE KEEP ALL PACKAGING MATERIAL FOR AT LEAST 90 DAYS IN CASE YOU NEED TO RETURN THIS PRODUCT TO YOUR PLACE OF PURCHASE OR MEMOREX.

FOR CONSUMER REPLACEABLE PART(S), SEE PART NUMBER(S) ON PAGES 4 AND 5 AND THEN CONTACT FOX INTERNATIONAL AT 1-800-321-6993.